



## World Class Clampseal® Throttling Valves

- *Replaceable Seat/Venturi*
- *Low Velocity Across Main Seat*
- *Precise Flow Control*
- *Pressure Seal Bonnet*



**Conval Clampseal® Throttling Valves are designed for a wide range of severe service applications requiring repeatable flow control and dependable shutoff.**



**STANDARD SIZES**

1/2" through 4"

**PRESSURE RATING**

ASME Class 900 through 3045

**STANDARD MATERIALS**

Carbon Steel SA105

Forged Alloy Steel 182 F22

Other materials available upon request

**OPTIONAL ACCESSORIES**

Actuators - Air, Motor, Hydraulic

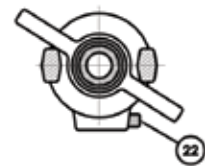
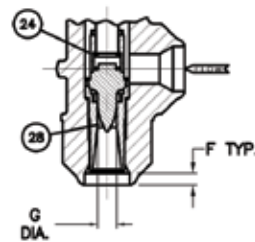
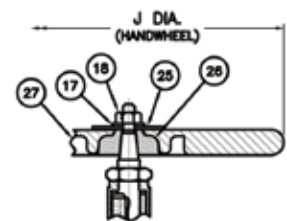
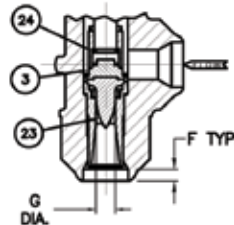

SECTION A - A

**DESIGN FEATURES**

**Replaceable 440C Stainless Steel Seat/Venturi**

The venturi is an integral part of the removable seat. It is readily changed in-line should different flow characteristics be required or replacement be necessary from excessive wear. The orifice is sized to keep fluid velocity across the seat below damaging levels. The exit orifice angle is designed to minimize downstream piping erosion and noise. Several erosion-resistant materials are available. Consult factory.

**Position Indicator**

The position indicator is easy to read and an accurate indication of valve stem position.

**Axially-loaded Packing System**

The packing is uniformly axially loaded. The bonnet cartridge packing chamber with a secure leakproof bonnet allows rapid access to valve trim for ease of inspection and maintenance.

**Mated Stem Assembly**

The stem assembly is mated to the orifice for proper control. Like the orifice seat assembly, it is readily changeable should different flow characteristics be required or excessive erosion occur.

**Pressure Seal Bonnet**

A secure, leakproof bonnet allows rapid access to valve trim for inspection and maintenance. The pressure boundary is sealed at the smallest diameter possible to ensure maximum sealing capability.

**Two-Year Warranty**

Conval is committed to unsurpassed quality. We are so confident of the quality of our product, that we offer a two-year warranty.

Clampseal® Throttling Valves is a registered trademark of Conval, Inc.

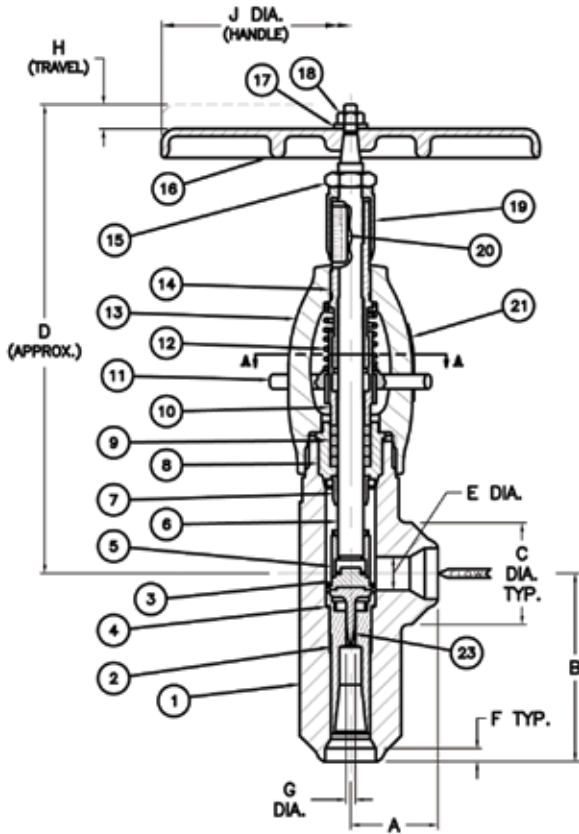

### LIST OF MATERIALS

NO.	NAME	QTY	MATERIAL	SPECIFICATIONS
1	BODY	1	CARBON STEEL	ASME SA-105
2	SEAT/ORIFICE	1	STAINLESS	ASTM A-276-440C
3	NEEDLE DISC	1	STELLITE NO. 6	AMS 5387
4	O-RING	1	STAINLESS	MFR. STD.
5	RETAINER	1	STAINLESS	ASTM A582-416
6	STEM	1	STAINLESS	ASTM A582-416
7	BACKSEAT	1	COBALT ALLOY NO. 21	ASTM A732-GR21
8	BONNET	1	STAINLESS	ASME SA479-410
9	PACKING SET	2	END/WIPER RINGS	BRAIDED CARBON YARN
		2	DIE FORMED RINGS	FLEXIBLE GRAPHITE
10	GLAND	1	STAINLESS	ATSTM A582-416
11	INTEGRAL GLAND WR	1	CAST STAINLESS	MFR. STD.
12	I.G.W. SPRING	1	STAINLESS	MFR. STD.
13	YOKE	1	*FORGED ALLOY STEEL	ASME SA-105
14	YOKE BUSHING	1	ALUMINUM BRONZE	ASME SB-150 UNS C64200
15	CHECK NUT	1	STEEL	MFR. STD.
16	HANDLE	1	MALLEABLE/DUCTILE IRON	MFR. STD.
17	WASHER	1	STEEL	MFR. STD.
18	LOCKNUT	1	STEEL	MFR. STD.
19	INDICATOR SLEEVE	1	STEEL	MFR. STD.
20	INDICATOR TAG	1	ALUMINUM	MFR. STD.
21	I.D. PLATE	1	STAINLESS	MFR. STD.
22	CLAMPBOLT	1	STAINLESS	MFR. STD.
23	NEEDLE	1	STAINLESS	ASTM A-276-440C
24	SPLIT RING	2	STAINLESS	ASME SA479-316
25	FLAT WASHER	1	STAINLESS	MFR. STD.
26	ADAPTER IMPACT*	1	MALLEABLE/DUCTILE IRON	MFR. STD.
27	HANDWHEEL*	1	MALLEABLE/DUCTILE IRON	MFR. STD.
28	NEEDLE DISC	1	STAINLESS	ASTM A-276-440C

A105, and SA 182 F316 and F22 Material combinations available upon request.  
 \*For over 2" size valves.

### DIMENSIONS

PRESSURE CLASS	Size Code	Pipe Size	A	B	C	D	E	F	H	J	Wgt		
NOMINAL	5E	1/2	2 5/16	4	2 5/16	10 7/32	11/16	1/2	5/8	8	13		
		3/4	2 5/16	4	2 5/16	10 7/32	11/16	1/2	5/8	8	13		
		1	2 5/16	4	2 5/16	10 7/32	11/16	1/2	5/8	8	13		
	900	7G	1	2 3/4	4 1/4	3 1/4	14 17/32	1 1/16	1/2	1 1/16	12	26	
			1 1/4	2 3/4	4 1/4	3 1/4	14 17/32	1 1/16	1/2	1 1/16	12	26	
		7G	1 1/2	2 3/4	4 1/4	3 1/4	14 17/32	1 1/16	1/2	1 1/16	12	26	
			2	2 3/4	4 1/4	3 1/4	14 17/32	1 1/16	5/8	1 1/16	12	26	
		1155	8H	2	3	4 1/2	3 15/16	16 15/32	1 9/32	5/8	1 5/32	12	40
				2 1/2	3	4 1/2	3 15/16	16 15/32	1 9/32	5/8	1 5/32	12	40
	10K		3	5	6	4 7/8	21 3/16	1 7/8	5/8	1 11/16	18	86	
			4	5	6	4 7/8	21 3/16	1 7/8	5/8	1 11/16	18	86	
	NOMINAL		5E	1/2	2 5/16	4	2 5/16	10 7/32	11/16	1/2	5/8	8	13
3/4				2 5/16	4	2 5/16	10 7/32	11/16	1/2	5/8	8	13	
1		2 5/16		4	2 5/16	10 7/32	11/16	1/2	5/8	8	13		
1500		7G	1	2 3/4	4 1/4	3 1/4	14 17/32	1 1/16	1/2	1 1/16	12	26	
			1 1/4	2 3/4	4 1/4	3 1/4	14 17/32	1 1/16	1/2	1 1/16	12	26	
		7G	1 1/2	2 3/4	4 1/4	3 1/4	14 17/32	1 1/16	1/2	1 1/16	12	26	
			2	2 3/4	4 1/4	3 1/4	14 17/32	1 1/16	5/8	1 1/16	12	26	
		2155	8H	2	3	4 1/2	3 15/16	16 15/32	1 9/32	5/8	1 5/32	12	40
				2 1/2	3	4 1/2	3 15/16	16 15/32	1 9/32	5/8	1 5/32	12	40
10K			3	5	6	4 7/8	21 3/16	1 7/8	5/8	1 11/16	18	86	
			4	5	6	4 7/8	21 3/16	1 7/8	5/8	1 11/16	18	86	
NOMINAL			5E	1/2	2 5/16	4	2 5/16	10 7/32	11/16	1/2	5/8	8	13
	3/4			2 5/16	4	2 5/16	10 7/32	11/16	1/2	5/8	8	13	
	1	2 5/16		4	2 5/16	10 7/32	11/16	1/2	5/8	8	13		
	2550	7G	1	2 3/4	4 1/4	3 1/4	14 17/32	1 1/16	1/2	1 1/16	12	26	
			1 1/4	2 3/4	4 1/4	3 1/4	14 17/32	1 1/16	1/2	1 1/16	12	26	
		7G	1 1/2	2 3/4	4 1/4	3 1/4	14 17/32	1 1/16	1/2	1 1/16	12	26	
			2	2 3/4	4 1/4	3 1/4	14 17/32	1 1/16	5/8	1 1/16	12	26	
		3045	8H	2	3	4 1/2	3 15/16	16 15/32	1 9/32	5/8	1 5/32	12	40
				2 1/2	3	4 1/2	3 15/16	16 15/32	1 9/32	5/8	1 5/32	12	40
	10K		3	5	6	4 7/8	21 3/16	1 7/8	5/8	1 11/16	18	86	
			4	5	6	4 7/8	21 3/16	1 7/8	5/8	1 11/16	18	86	

\* Socket Weld dimensions shown; Consult factory for Butt Weld dimensions.  
 Numbers shown in Black indicate dimensions in inches, weight in pounds. Numbers shown in blue indicate dimensions in mm, weight in kilograms.  
 Butt Weld dimensions determined by pipe schedule.  
 NOTE: All weights are approximate for shipping purposes only.

### TYPICAL FLOW CHART

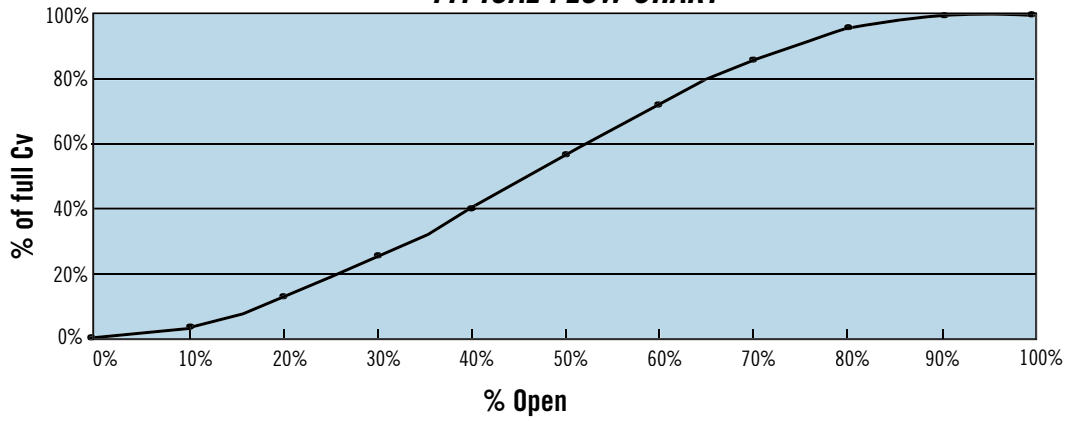

### SPECIFICATIONS

Size Code	Pipe Size	Cv/Kv																					
		Standard Orifice Size																					
		1/8	3/16	1/4	5/16	3/8	7/16	1/2	9/16	5/8	11/16	3/4	13/16	7/8	15/16	1	1 1/16	1 1/8	1 3/16	1 1/4	1 3/8	1 1/2	
		3.2	4.8	6.4	7.9	9.5	11.1	12.7	14.3	15.9	17.5	19.1	20.6	22.2	23.8	25.4	27.0	28.6	30.2	31.6	34.9	38.1	
5E	1/2	15																					
	3/4	20	0.42	1.1	2.4																		
	1	25	0.36	1.0	2.0																		
7G	1	25																					
	1 1/4	32	0.5	1.1	2.1	3	5	7	9	11													
	1 1/2	40	0.4	1.0	1.8	3	4	6	8	10													
8H	2	50																					
	1 1/4	32																					
	1 1/2	40				5	6	8	10	13	15	18											
10K	2	50																					
	2 1/2	65							13	16	19	22	25	28	31	35	38	42	46	49	59	64	
	3	80							11	14	16	19	22	24	27	30	33	36	40	42	51	55	
	4	100																					

Numbers shown in black indicate dimensions in inches/Cv. Numbers shown in blue indicate dimensions in mm/Kv.

**Example:**

Given:

Steam

P1 = 1000 (psi) Super heat = 105(F deg)

P2 = 800 (psi)

T = 650 (deg.F)

Flow Rate = 20,000 (lbs/hr)

- 1) Calculate outlet pressure as % of inlet pressure

Since outlet pressure is greater than 55% of inlet pressure, we must multiply capacity by the correction factor. From the curve, the correction factor = .85.

$$.85 (20,000) = 17,000 \text{ (lbs/hr)}$$

- 2) If steam is super heated, adjust capacity.

For 105 (F deg) Super Heated Steam:

$$\text{Capacity} = 17,000 [1 + .00065(105)] = 18,160 \text{ (lbs/hr)}$$

- 3) Size Orifice from chart above using:

Inlet Pressure = 1,000 (psi)

Flow Rate = 18,160 (lbs/hr)

Find the intersection point on chart.

Correct orifice size is directly above and to the left of the intersection point.

In this case we would use an 11/16" orifice. Adjust for superheat conditions by multiplying the required flow rate by (1 + .00065 x degrees superheat) prior to cross referencing.

**Saturated Steam**

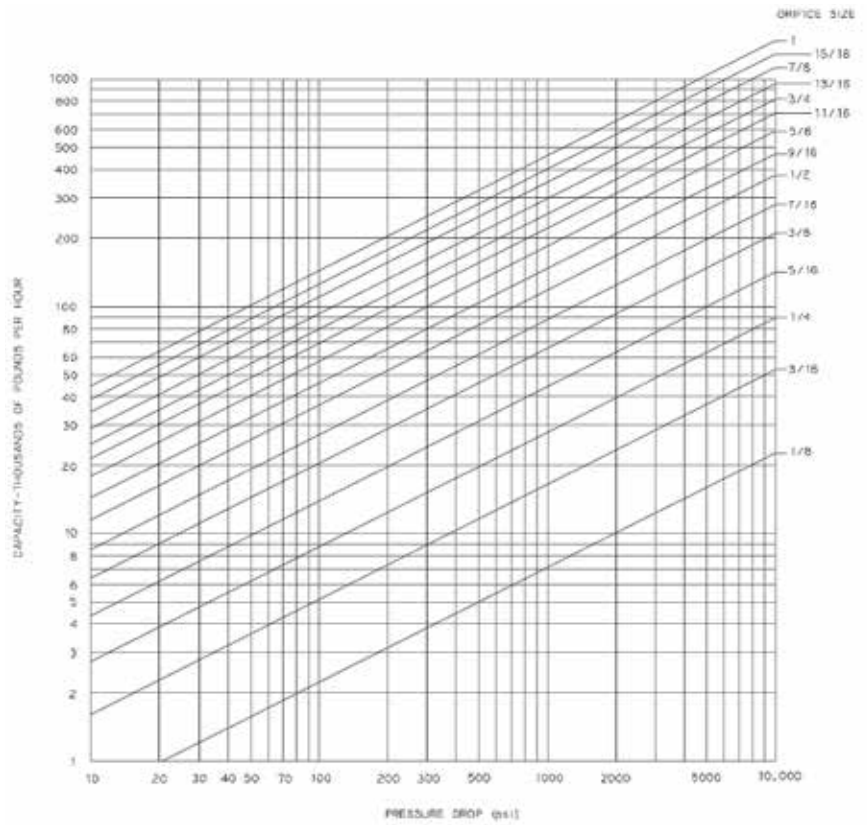

**Correction Factor**

If outlet pressure is greater than 55% of the inlet pressure, multiply capacity by the correction factor below:

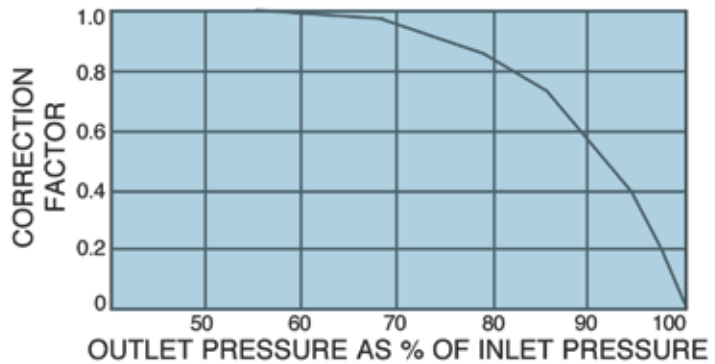

**Example:**

Given:

Water

P1 = 1000 (psi)

$\Delta P = 1000$  (psi)

T = 350 (deg.F)

Flow Rate = 10,000 (lbs/hr)

Vapor Pressure = 135 (psi)

- 1) Since  $T > 300$ , we must use a corrected max. pressure drop.

$$\Delta P = .9 \times (1000 - .83 \times 135)$$

$$\Delta P = 799.155$$

- 2) Size orifice from chart using:

$$\Delta P = 799.155$$

Flow Rate = 10,000

Find the intersection point on the chart. Correct orifice size is directly above and to the left of the intersection point. In this case we would use a 3/16" orifice.

**Liquid**

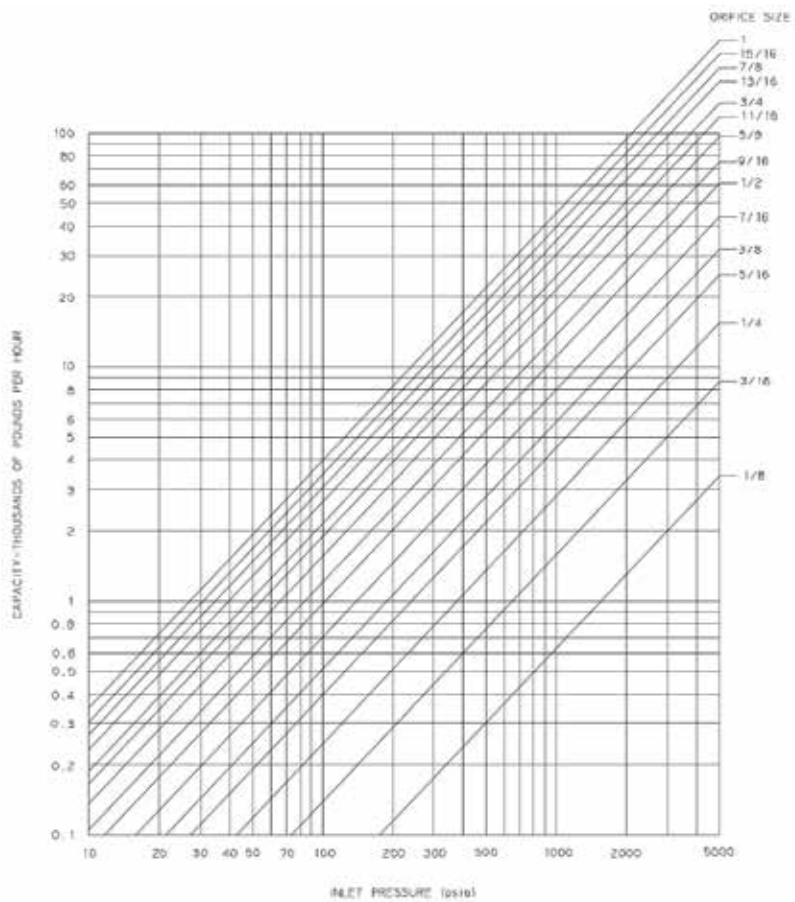

**Correction Factor**

If temperature is greater than 300°F choked flow may occur. Therefore the maximum pressure drop used for sizing is given by:

$$P = .9 (P1 - .83 \times Pv)$$

Where P1 = inlet pressure

Pv = vapor pressure



**Cv vs Handle Turns for a 5E Throttle Valve with 1/8" Orifice**

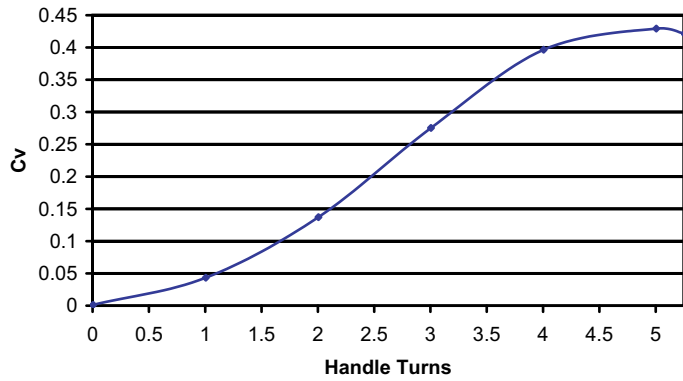

**Cv vs % Open for a 5E Throttle Valve with 1/8" Orifice**

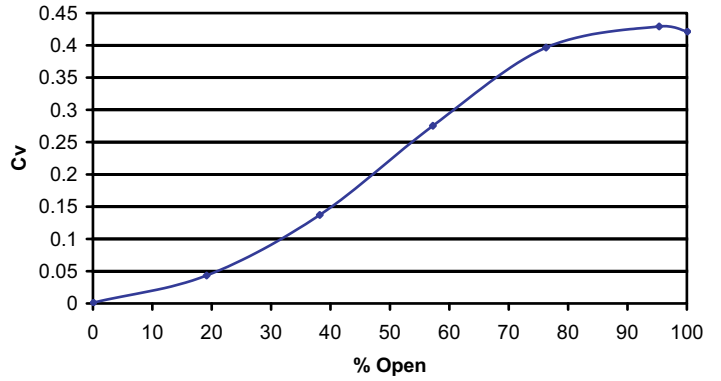

**Cv vs % Open for a 5E Throttle Valve with 3/16" Orifice**

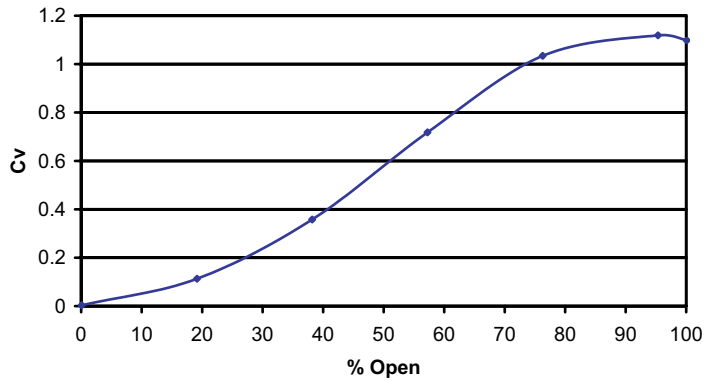

**Cv vs Handle Turns for a 5E Throttle Valve with 3/16" Orifice**



**Cv vs % Open for a 5E Throttle Valve with 1/4" Orifice**

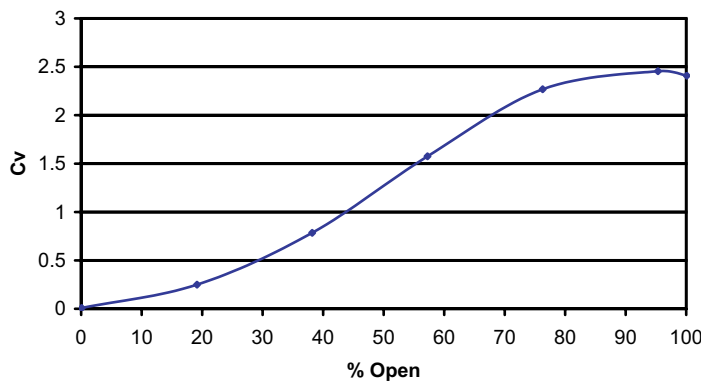

**Cv vs Handle Turns for a 5E Throttle Valve with 1/4" Orifice**

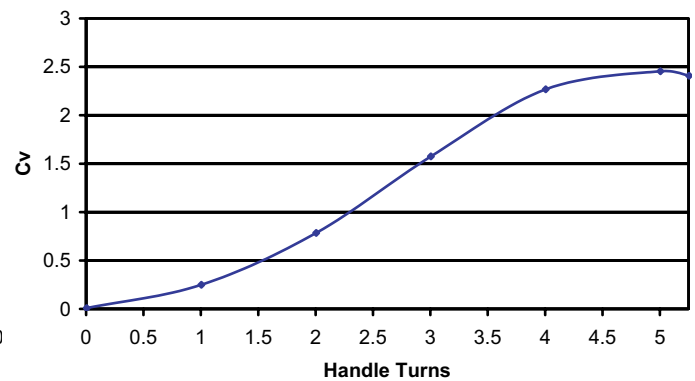

**Cv vs % Open for a 7G Throttle Valve with 1/8" Orifice**

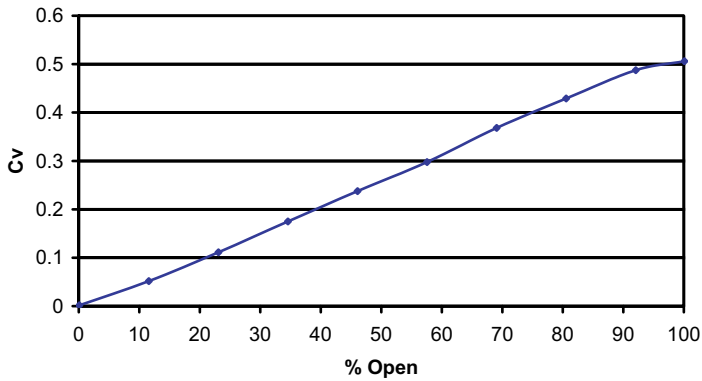

**Cv vs Handle Turns for a 7G Throttle Valve with 1/8" Orifice**

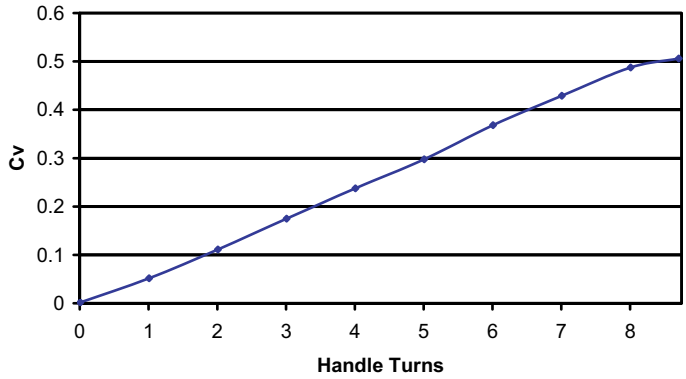

**Cv vs Handle Turns for a 7G Throttle Valve with 3/16" Orifice**



**Cv vs % Open for a 7G Throttle Valve with 3/16" Orifice**

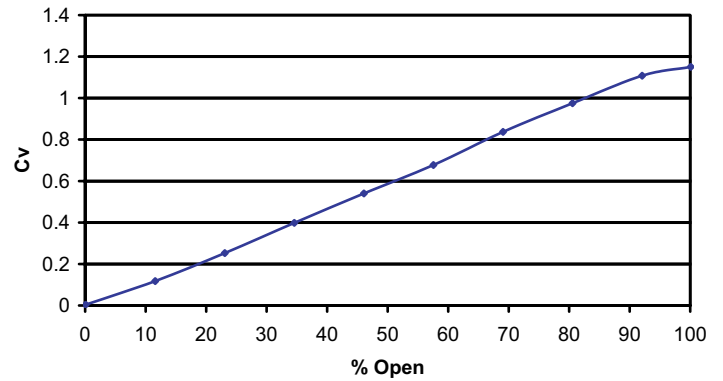

**Cv vs % Open for a 7G Throttle Valve with 1/4" Orifice**

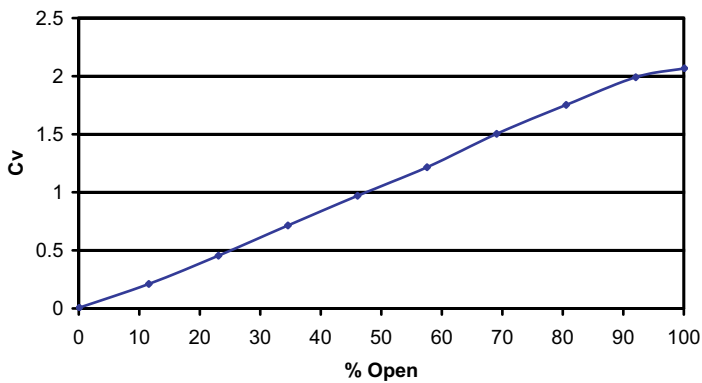

**Cv vs Handle Turns for a 7G Throttle Valve with 1/4" Orifice**

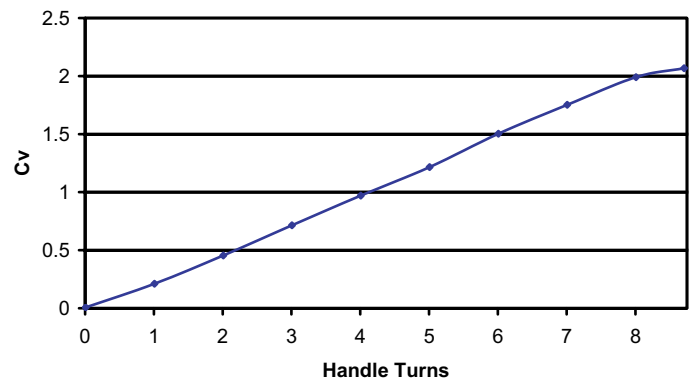



**Cv vs Handle Turns for a 7G Throttle Valve with 5/16" Orifice**

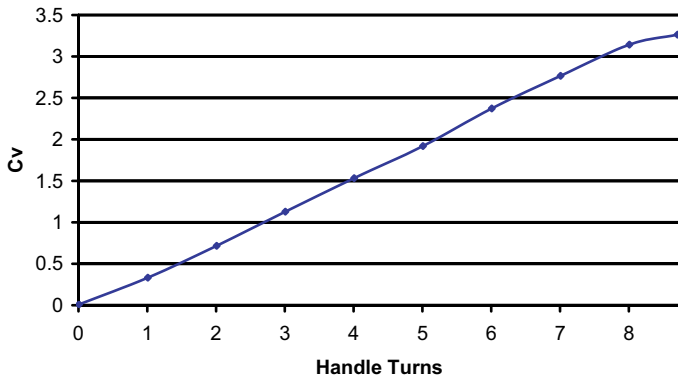

**Cv vs % Open for a 7G Throttle Valve with 5/16" Orifice**

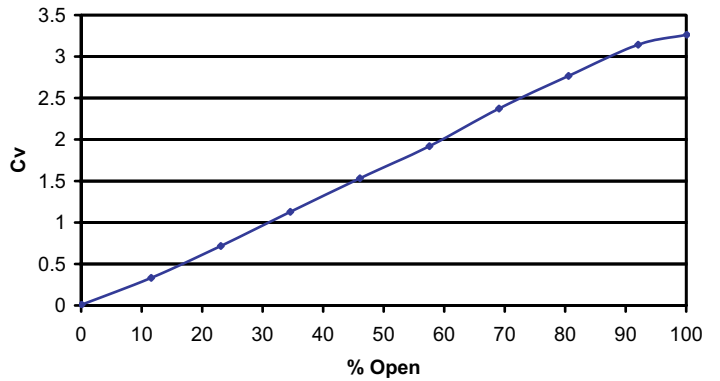

**Cv vs % Open for a 7G Throttle Valve with 3/8" Orifice**

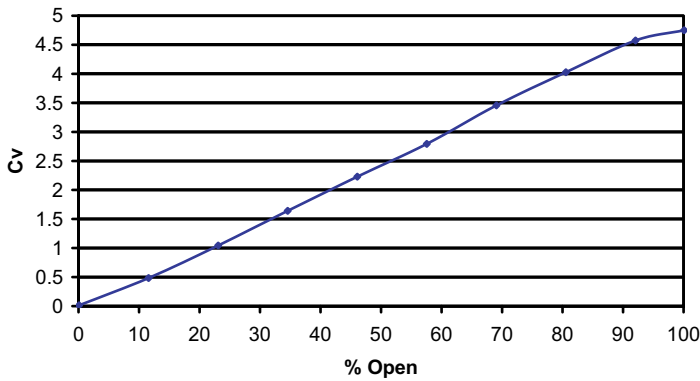

**Cv vs Handle Turns for a 7G Throttle Valve with 3/8" Orifice**

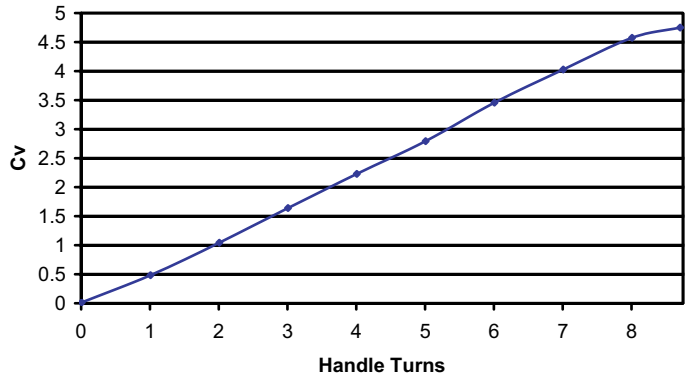

**Cv vs % Open for a 7G Throttle Valve with 7/16" Orifice**

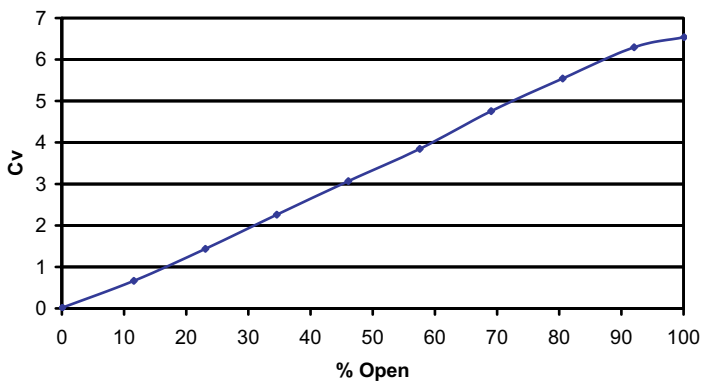

**Cv vs Handle Turns for a 7G Throttle Valve with 7/16" Orifice**

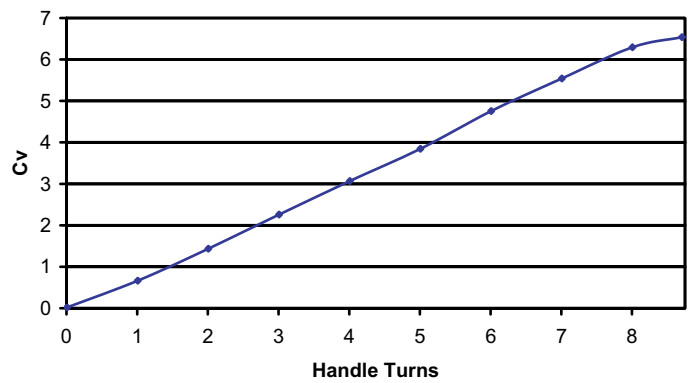

**Cv vs Handle Turns for a 7G Throttle Valve with 1/2" Orifice**



**Cv vs % Open for a 7G Throttle Valve with 1/2" Orifice**

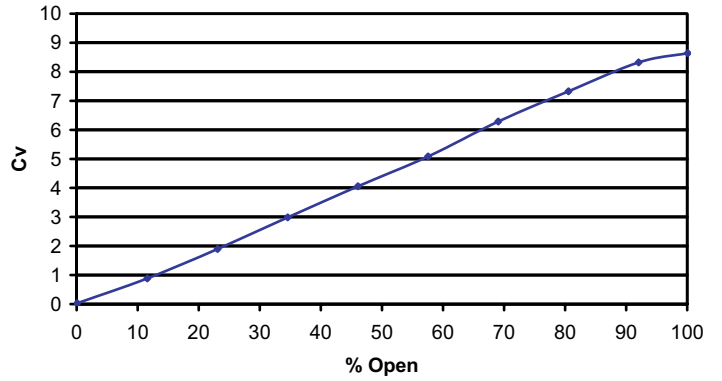

**Cv vs % Open for a 7G Throttle Valve with 9/16" Orifice**

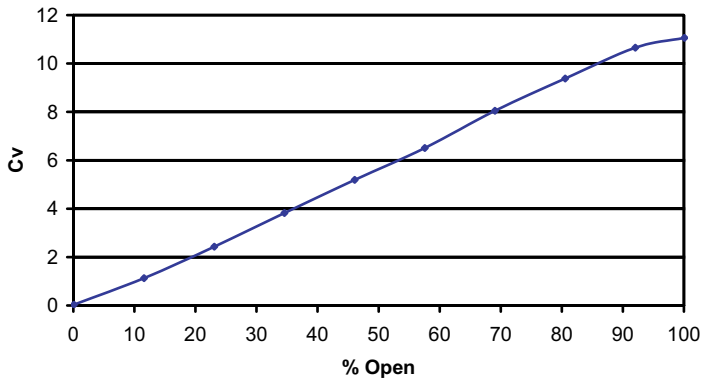

**Cv vs Handle Turns for a 7G Throttle Valve with 9/16" Orifice**

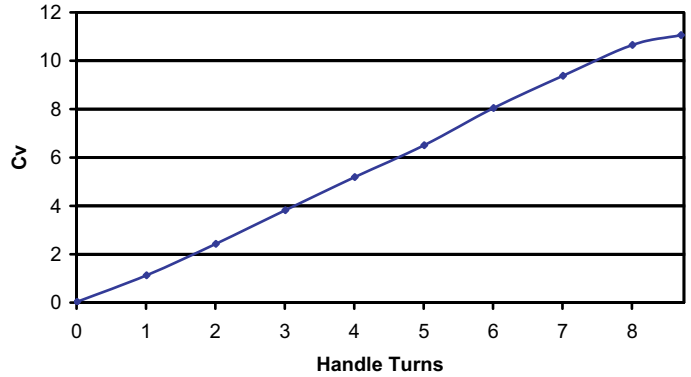

**Cv vs % Open for a 8H Throttle Valve with 3/8" Orifice**

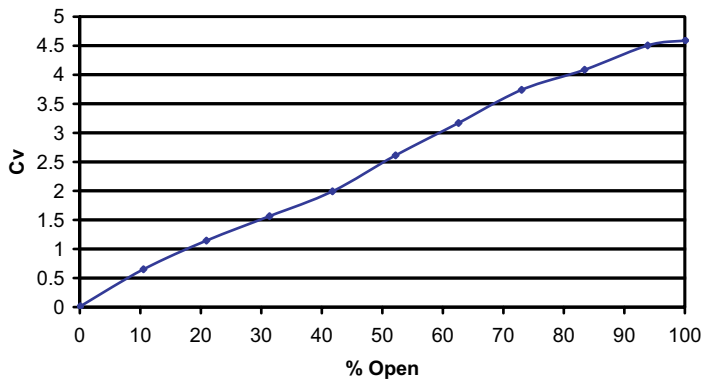

**Cv vs Handle Turns for a 8H Throttle Valve with 3/8" Orifice**



**Cv vs Handle Turns for a 8H Throttle Valve with 7/16" Orifice**



**Cv vs % Open for a 8H Throttle Valve with 7/16" Orifice**

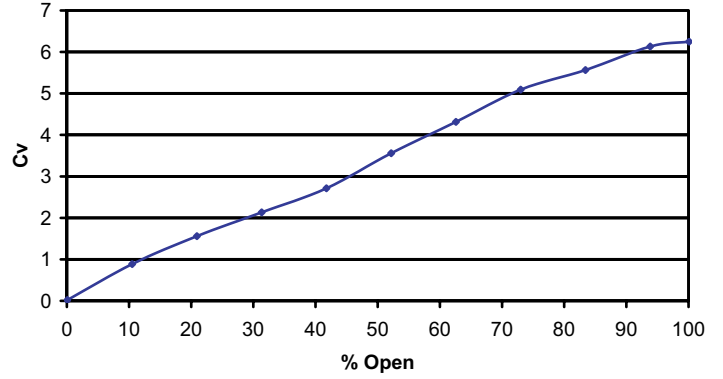

**Cv vs Handle Turns for a 8H Throttle Valve with 1/2" Orifice**

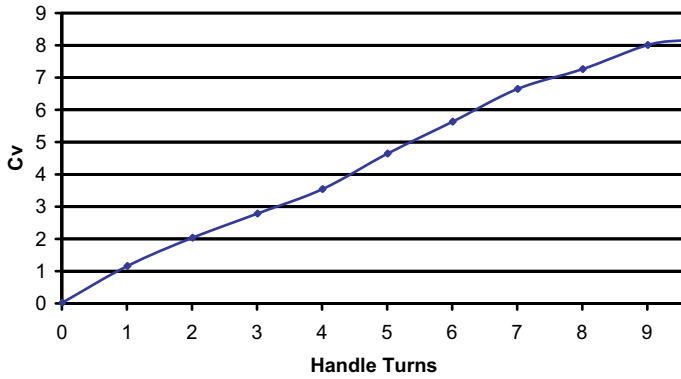

**Cv vs % Open for a 8H Throttle Valve with 1/2" Orifice**

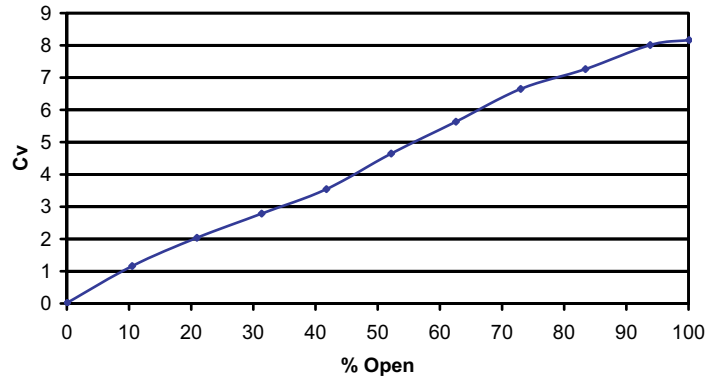

**Cv vs % Open for a 8H Throttle Valve with 9/16" Orifice**

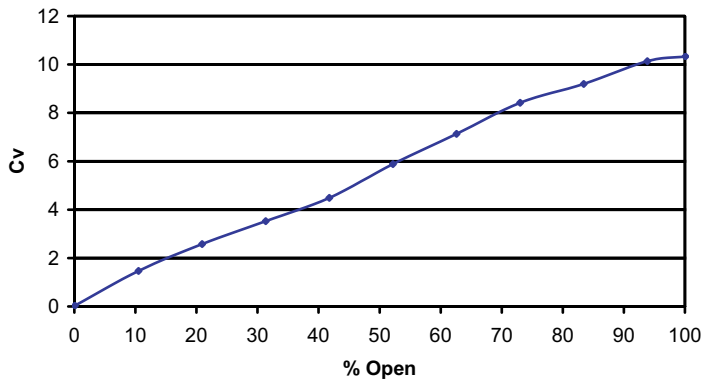

**Cv vs Handle Turns for a 8H Throttle Valve with 9/16" Orifice**

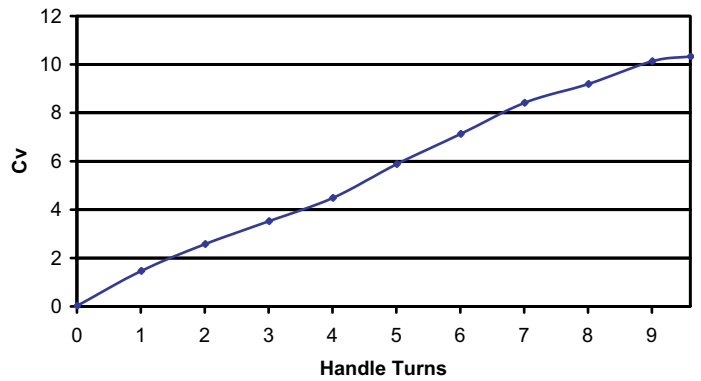

**Cv vs Handle Turns for a 8H Throttle Valve with 5/8" Orifice**



**Cv vs % Open for a 8H Throttle Valve with 5/8" Orifice**

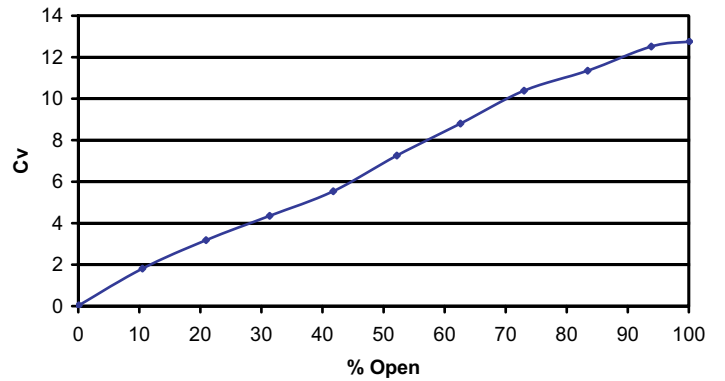

**Cv vs Handle Turns for a 8H Throttle Valve with 11/16" Orifice**



**Cv vs % Open for a 8H Throttle Valve with 11/16" Orifice**

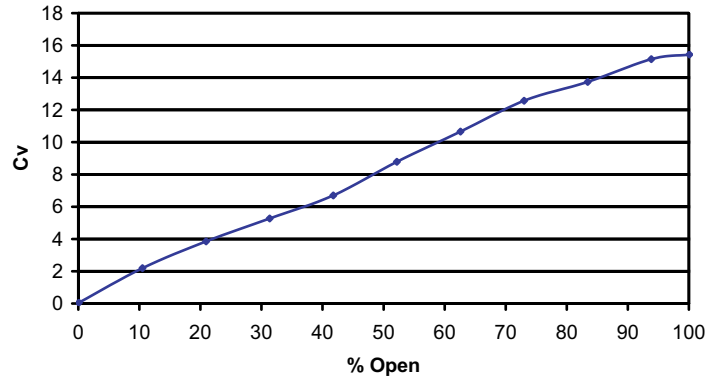

**Cv vs % Open for a 8H Throttle Valve with 3/4" Orifice**

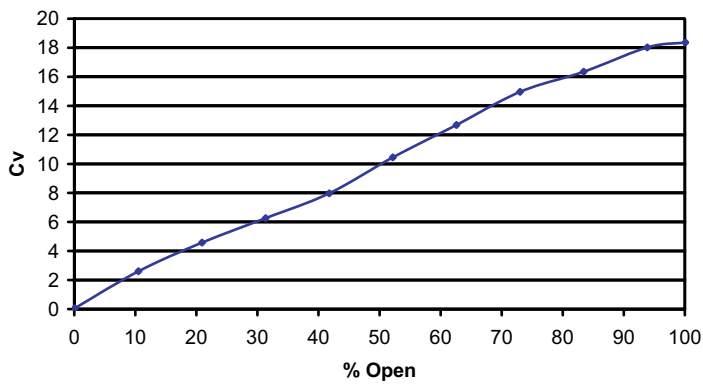

**Cv vs Handle Turns for a 8H Throttle Valve with 3/4" Orifice**

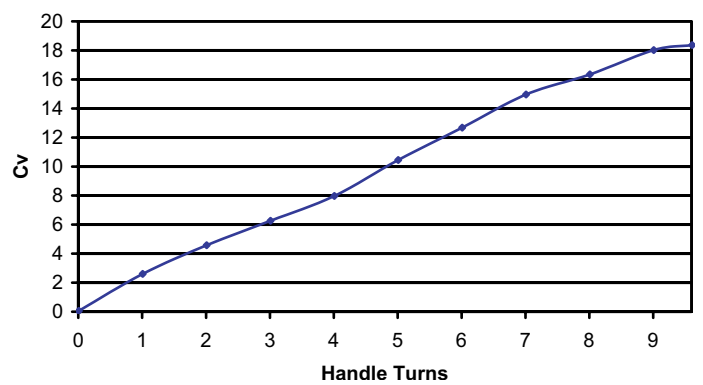

**Cv vs Handle Turns for a 10K Throttle Valve with 9/16" Orifice**

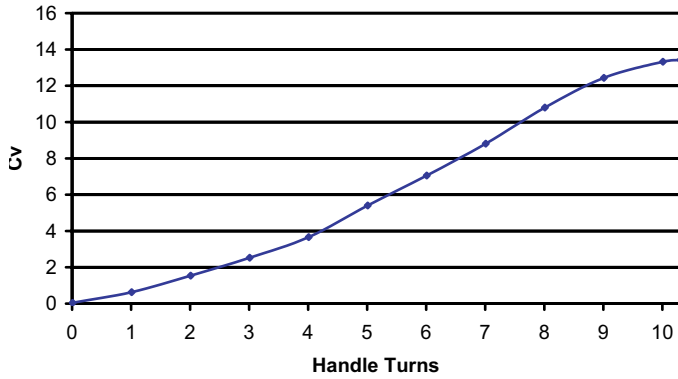

**Cv vs % Open for a 10K Throttle Valve with 9/16" Orifice**

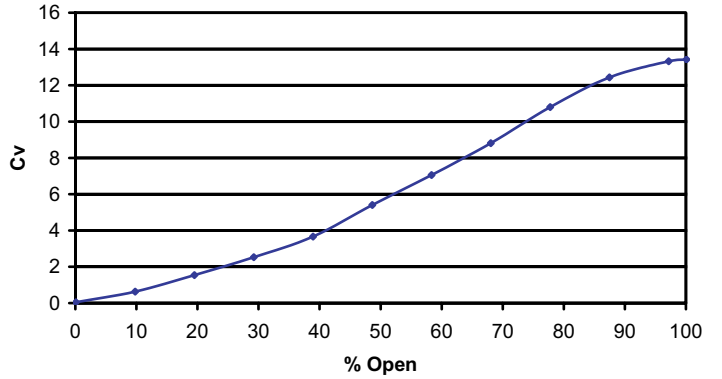

**Cv vs Handle Turns for a 10K Throttle Valve with 5/8" Orifice**



**Cv vs % Open for a 10K Throttle Valve with 5/8" Orifice**

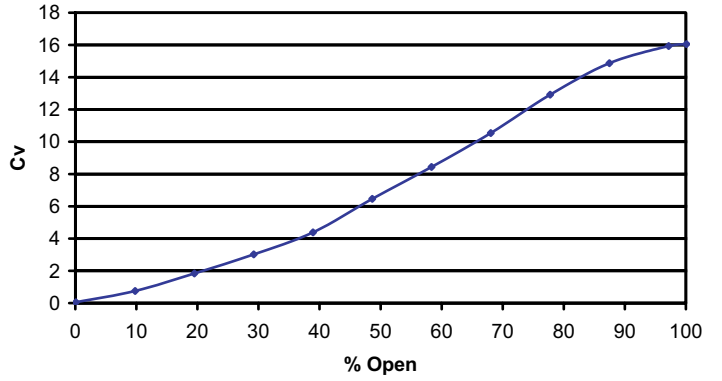

**Cv vs Handle Turns for a 10K Throttle Valve with 11/16" Orifice**



**Cv vs % Open for a 10K Throttle Valve with 11/16" Orifice**

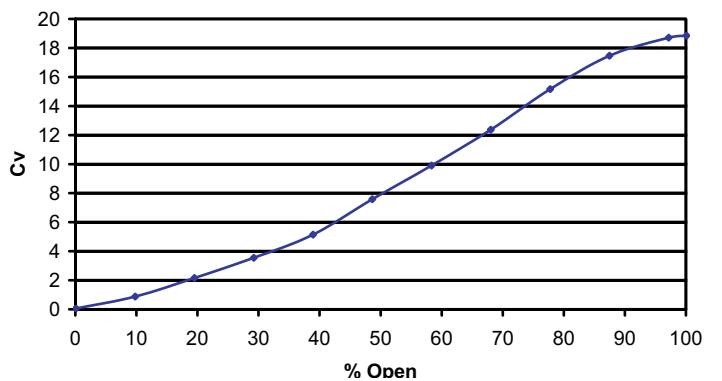

**Cv vs Handle Turns for a 10K Throttle Valve with 3/4" Orifice**

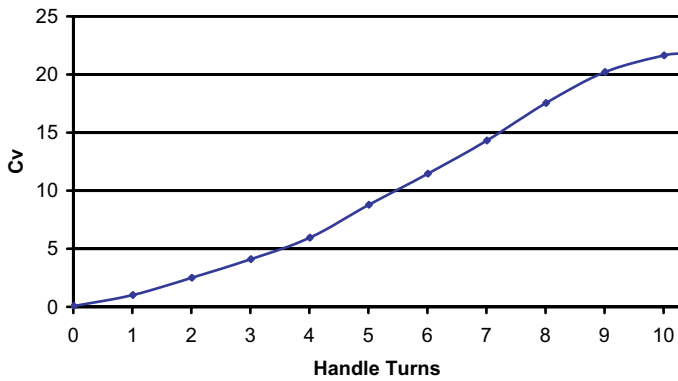

**Cv vs % Open for a 10K Throttle Valve with 3/4" Orifice**

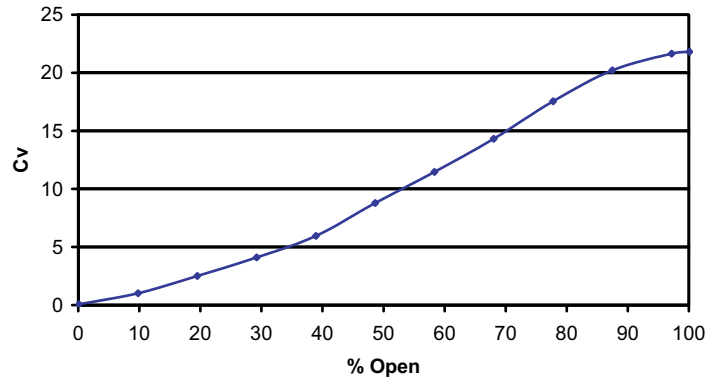

**Cv vs Handle Turns for a 10K Throttle Valve with 13/16" Orifice**

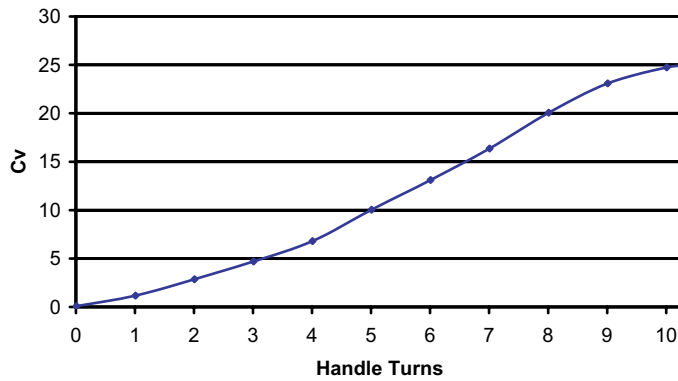

**Cv vs % Open for a 10K Throttle Valve with 13/16" Orifice**

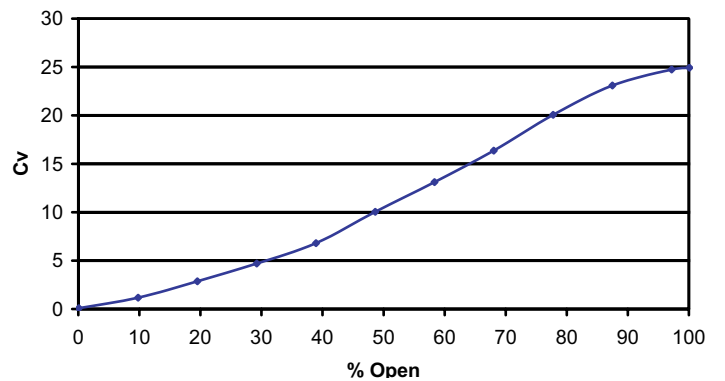

**Cv vs Handle Turns for a 10K Throttle Valve with 7/8" Orifice**

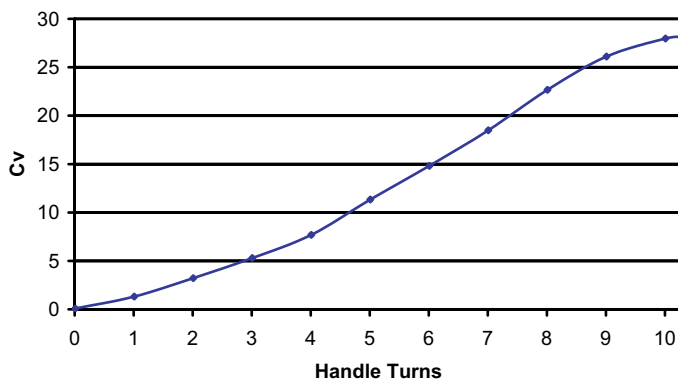

**Cv vs % Open for a 10K Throttle Valve with 7/8" Orifice**

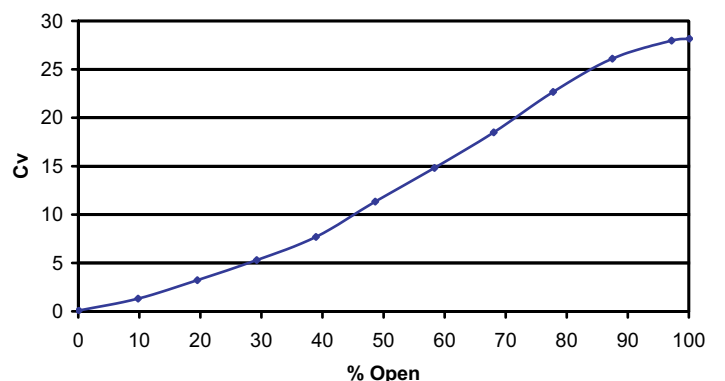

**Cv vs Handle Turns for a 10K Throttle Valve with 15/16" Orifice**



**Cv vs % Open for a 10K Throttle Valve with 15/16" Orifice**

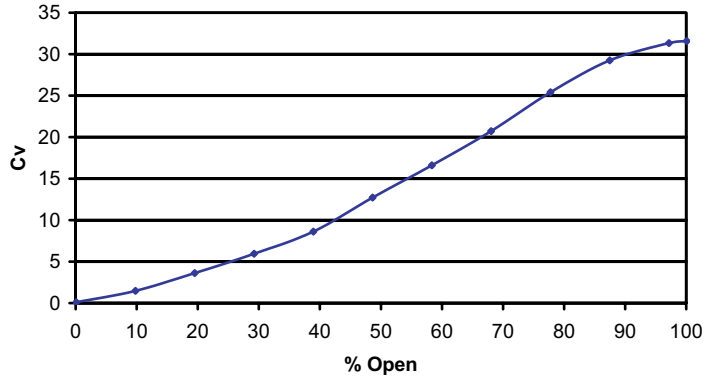

**Cv vs Handle Turns for a 10K Throttle Valve with 1" Orifice**



**Cv vs % Open for a 10K Throttle Valve with 1" Orifice**

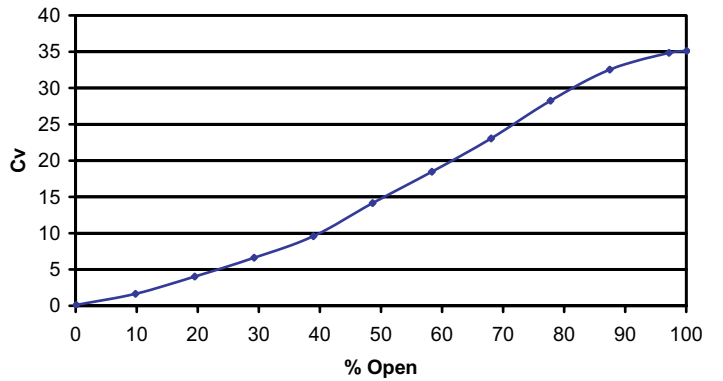



## The Conval Story

In 1962, Mr. Chester Siver completed designs for a revolutionary line of high-pressure, forged steel valves. Hamilton Standard (now Hamilton Sunstrand), a division of United Technologies Corporation, was asked to use their then-new Electron Beam Welding technology for joining of parts into valves for subassemblies. Hamilton Standard became intrigued with the valve as an ideal application of the Electron Beam Welding technique, and negotiated a contract for the rights to manufacture and sell the valve. Mr. Siver served as manager of the valve project.



The first CLAMPSEAL® valves were introduced to the market by Hamilton Standard in 1964. However, in the mid-1960's, growing demand for the firm's popular aerospace products forced Hamilton Standard to make the decision to abandon its industrial products projects. The rights to the CLAMPSEAL valve reverted back to Mr. Siver. Since CLAMPSEAL valves were born in Connecticut, Mr. Siver founded "Conval" (short for Connecticut Valve) in 1967. Today, the valves are still manufactured in Connecticut, a state with a longstanding reputation for technological innovation and manufacturing excellence.

Founded in 1967, Conval has grown into a leader in valves for the world's most demanding applications. We have a global team of experts to help to meet your most challenging needs. We invite you to contact us today.

High-pressure, high-temperature ball, bellows, bonnetless, check, gate, globe, throttling, and urea service valves for the world's most demanding applications.



*Thank you for your business!*  
*ISO 9001 certified since 1992*  
*PED certified since 2003*  
*Nuclear N-stamp since 2006*



# Conval INC.

World Headquarters: 96 Phoenix Avenue, Enfield, CT 06082 USA

Phone (860) 749-0761 Fax (860) 763-3557

e-mail: [sales@Conval.com](mailto:sales@Conval.com) [www.Conval.com](http://www.Conval.com)



**Vinnova Exploration**  
[sales@vinnova.asia](mailto:sales@vinnova.asia)  
063-271-9119  
[www.vinnova.asia](http://www.vinnova.asia)

Conval's policy is one of continuous development and improvement. Every effort is made to produce up-to-date literature but this catalog should not be regarded as an infallible guide to current specifications and does not form part of any contract. Conval reserves the right to make product improvements and changes without prior notice.